

## Three-Terminal Low Current Positive Voltage Regulators

### FEATURES

- Wide range of available, fixed output voltage.
- Low cost.
- Internal short-circuit current limiting.
- Internal thermal overload protection.
- No external components required.
- Complementary negative regulators offered (SL79LXX series).

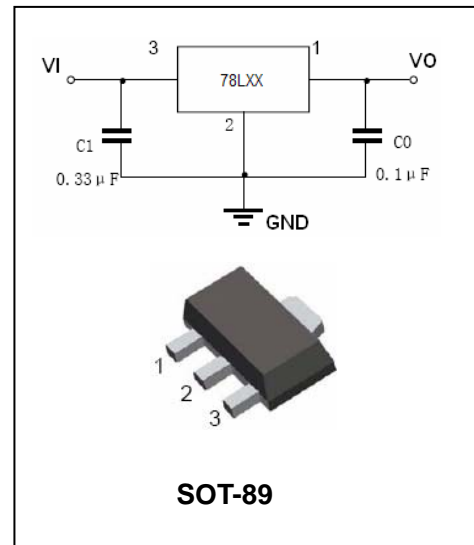

### APPLICATIONS

- Three-terminal positive voltage regulator.

### ORDERING INFORMATION

Type No.	Marking	Package Code
SL78LXX	78LXX	SOT-89

### MAXIMUM RATING operating temperature range applies unless otherwise specified

Symbol	Parameter	Value	Units
$V_I$	Input voltage(3.3V-9V) (10V-15V) (18V-24V)	30 35 40	V
$I_{CM}$	Maximum output current	100	mA
$P_D$	Power dissipation	500	mW
$T_{OPR}$	Operating junction temperature	0 to +125	°C
$T_j, T_{stg}$	Storage temperature range	-40 to +150	°C

**ELECTRICAL CHARACTERISTICS**

 ( $V_{IN}=10V, I_O=40mA, 0^{\circ}C < T_J < 125^{\circ}C, C_I=0.33\mu F, C_O=0.1\mu F$ , unless otherwise specified)

Parameter	Symbol	Test conditions	SL78L33			UNIT
			MIN	TYP	MAX	
Output voltage	$V_O$	$T_J=25^{\circ}C$	3.168	3.3	3.432	V
		$5.3V \leq V_i \leq 20V, I_O=1mA-40mA$	3.135		3.465	
		$V_i=8.3V, I_O=1mA-70mA$	3.135		3.465	
Load regulation	$Reg_{load}$	$T_J=25^{\circ}C, I_O=1mA-100mA$			60	mV
		$T_J=25^{\circ}C, I_O=1mA-40mA$			30	
Line regulation	$Reg_{line}$	$5.3V \leq V_i \leq 20V, T_J=25^{\circ}C$			150	mV
		$6.3V \leq V_i \leq 20V, T_J=25^{\circ}C$			100	
Input Bias Current	$I_{IB}$	$T_J=25^{\circ}C$			6.0	mA
		$T_J=125^{\circ}C$			5.5	
Input Bias Current Change	$\Delta I_{IB}$	$6.3V \leq V_i \leq 20V$			1.5	mA
		$1mA \leq I_O \leq 40mA$			0.1	
Output noise voltage	$V_N$	$10Hz \leq f \leq 100KHz$		40		$\mu V$
Ripple rejection	RR	$I_O=40mA, 6.3V \leq V_i \leq 16.3V$ $f=120Hz, T_J=25^{\circ}C$	41	49		dB
Dropout voltage	$V_i-V_O$	$T_J=25^{\circ}C$		1.7		V

**ELECTRICAL CHARACTERISTICS**

 ( $V_{IN}=10V, I_O=40mA, 0^{\circ}C < T_J < 125^{\circ}C, C_I=0.33\mu F, C_O=0.1\mu F$ , unless otherwise specified)

Parameter	Symbol	Test conditions	SL78L05			UNIT
			MIN	TYP	MAX	
Output voltage	$V_O$	$T_J=25^{\circ}C$	4.8	5.0	5.2	V
		$7V \leq V_i \leq 20V, I_O=1mA-40mA$	4.75		5.25	
		$V_i=10V, I_O=1mA-70mA$	4.75		5.25	
Load regulation	$Reg_{load}$	$T_J=25^{\circ}C, I_O=1mA-100mA$		11	60	mV
		$T_J=25^{\circ}C, I_O=1mA-40mA$		5	30	
Line regulation	$Reg_{line}$	$7V \leq V_i \leq 20V, T_J=25^{\circ}C$		55	150	mV
		$8V \leq V_i \leq 20V, T_J=25^{\circ}C$		45	100	
Input Bias Current	$I_{IB}$	$T_J=25^{\circ}C$		3.8	6.0	mA
		$T_J=125^{\circ}C$			5.5	
Input Bias Current Change	$\Delta I_{IB}$	$8V \leq V_i \leq 20V$			1.5	mA
		$1mA \leq I_O \leq 40mA$			0.1	
Output noise voltage	$V_N$	$10Hz \leq f \leq 100KHz$		40		$\mu V$
Ripple rejection	RR	$I_O=40mA, 8V \leq V_i \leq 18V, f=120Hz$ $T_J=25^{\circ}C$	41	49		dB
Dropout voltage	$V_i-V_O$	$T_J=25^{\circ}C$		1.7		V

**ELECTRICAL CHARACTERISTICS**

 ( $V_{IN}=12V, I_O=40mA, 0^{\circ}C < T_J < 125^{\circ}C, C_I=0.33\mu F, C_O=0.1\mu F$ , unless otherwise specified)

Parameter	Symbol	Test conditions	SL78L06			UNIT
			MIN	TYP	MAX	
Output voltage	$V_O$	$T_J=25^{\circ}C$ $V_1=8.5V-20V, I_O=1mA-40mA$ $V_1=8.5V, I_O=1mA-70mA$	5.75 5.7 5.7	6.0	6.25 6.3 6.3	V
Load regulation	$Reg_{load}$	$T_J=25^{\circ}C, I_O=1mA-100mA$ $T_J=25^{\circ}C, I_O=1mA-70mA$		12.8 5.8	80 40	mV
Line regulation	$Reg_{line}$	$8.5V \leq V_i \leq 20V, T_J=25^{\circ}C$ $9V \leq V_i \leq 20V, T_J=25^{\circ}C$		64 54	175 125	mV
Input Bias Current	$I_{IB}$	$T_J=25^{\circ}C, V_{IN}=12V, I_O=40mA$ $T_J=125^{\circ}C, V_{IN}=12V, I_O=40mA$		3.9	5.5 6.0	mA
Input Bias Current Change	$\Delta I_{IB}$	$9V \leq V_i \leq 20V$ $1mA \leq I_O \leq 40mA$			1.5 0.1	mA
Output noise voltage	$V_N$	$10Hz \leq f \leq 100KHz$		40		$\mu V/V_O$
Ripple rejection	RR	$I_O=40mA, 10V \leq V_i \leq 20V, f=120Hz,$ $T_J=25^{\circ}C$	40	46		dB
Dropout voltage	$V_D$	$T_J=25^{\circ}C$		1.7		V

**ELECTRICAL CHARACTERISTICS**

 ( $V_i=14V, I_O=40mA, 0^{\circ}C < T_J < 125^{\circ}C, C_I=0.33\mu F, C_O=0.1Mf$ , unless otherwise specified)

Parameter	Symbol	Test conditions	SL78L08			UNIT
			MIN	TYP	MAX	
Output voltage	$V_O$	$T_J=25^{\circ}C$ $10.5V \leq V_i \leq 23V, I_O=1mA-40mA$ $V_i=14V, I_O=1mA-70mA$	7.7 7.6 7.6	8.0	8.3 8.4 8.4	V
Load regulation	$Reg_{load}$	$T_J=25^{\circ}C, I_O=1mA-100mA$ $T_J=25^{\circ}C, I_O=1mA-40mA$		15 8.0	80 40	mV
Line regulation	$Reg_{line}$	$10.5V \leq V_i \leq 23V, T_J=25^{\circ}C$ $11V \leq V_i \leq 23V, T_J=25^{\circ}C$		20 12	175 125	mV
Input Bias Current	$I_{IB}$	$T_J=25^{\circ}C$ $T_J=125^{\circ}C$		3	6.0 5.5	mA
Input Bias Current Change	$\Delta I_{IB}$	$11V \leq V_i \leq 23V$ $1mA \leq I_O \leq 40mA$			1.5 0.1	mA
Output noise voltage	$V_N$	$T_A=25^{\circ}C, 10Hz \leq f \leq 100KHz$		60		$\mu V$
Ripple rejection	RR	$I_O=40mA, 12V \leq V_i \leq 23V, f=120Hz,$ $T_J=25^{\circ}C$	37	57		dB
Dropout voltage	$V_i-V_O$	$T_J=25^{\circ}C$		1.7		V

**ELECTRICAL CHARACTERISTICS**

 ( $V_i=15V, I_o=40mA, 0^{\circ}C < T_j < 125^{\circ}C, C_i=0.33\mu F, C_o=0.1\mu F$ , unless otherwise specified)

Parameter	Symbol	Test conditions	SL78L09			UNIT
			MIN	TYP	MAX	
Output voltage	$V_o$	$T_j=25^{\circ}C$	8.6	9.0	9.4	V
		$V_i=11.5V-24V, I_o=1mA-40mA$	8.5		9.5	
		$V_i=15V, I_o=1mA-70mA$	8.5		9.5	
Load regulation	$Reg_{load}$	$T_j=25^{\circ}C, I_o=1mA-100mA$		15	90	mV
		$T_j=25^{\circ}C, I_o=1mA-40mA$		8.0	40	
Line regulation	$Reg_{line}$	$11.5V \leq V_i \leq 24V, T_j=25^{\circ}C$		20	175	mV
		$12V \leq V_i \leq 24V, T_j=25^{\circ}C$		12	125	
Input Bias Current	$I_{IB}$	$T_j=25^{\circ}C$		3.0	6.0	mA
		$T_j=125^{\circ}C$			5.5	
Input Bias Current Change	$\Delta I_{IB}$	$11V \leq V_i \leq 23V$ $1mA \leq I_o \leq 40mA$			1.5 0.1	mA
Output noise voltage	$V_N$	$T_A=25^{\circ}C, 10Hz \leq f \leq 100KHz$		60		$\mu V$
Ripple rejection	RR	$I_o=40mA, 13V \leq V_i \leq 24V, f=120Hz, T_j=25^{\circ}C$	37	57		dB
Dropout voltage	$V_i-V_o$	$T_j=25^{\circ}C$		1.7		V

**ELECTRICAL CHARACTERISTICS**

 ( $V_{IN}=16V, I_O=40350mA, C_{IN}=0.33\mu F, C_O=0.1\mu f, T_j = 0$  to  $125^\circ C$  , unless otherwise specified)

Parameter	Symbol	Test conditions	SL78L10			UNIT
			MIN	TYP	MAX	
Output voltage	$V_O$	$T_J=25^\circ C$	9.6	10	10.4	V
Load regulation(Note1)	$\Delta Reg_{load}$	$I_O = 1$ to $100mA$ , $T_j = 25^\circ C$	-	17	90	mV
		$I_O = 1$ to $40mA$ , $T_j = 25^\circ C$	-	9	45	mV
Line regulation(Note1)	$\Delta Reg_{line}$	$V_I = 12.5$ to $25V$ , $T_j = 25^\circ C$	-	100	210	mV
		$V_I = 13$ to $25V$ , $T_j = 25^\circ C$	-	90	160	mV
Input Bias Current	$I_{IB}$	$T_j = 25^\circ C$	-	2.0	3.0	mA
Input Bias Current Change	$\Delta I_{IB}$	$V_I = 13$ to $25V$ , $T_j = 25^\circ C$	-	-	1.0	mA
Output Noise Voltage	$V_N$	$10Hz \leq f \leq 100KHz$	-	70	-	$\mu V$
Ripple Rejection	RR	$V_I = 13$ to $23V$ , $I_O = 40mA$ , $f = 120Hz$	42	52	-	dB
Dropout Voltage	$V_D$	$T_J=25^\circ C$	-	1.7	-	V
Dropout voltage	$V_I-V_O$	$I_O = 5mA, T_j = 0$ to $125^\circ C$	-	0.9	-	$mV/^\circ C$

**ELECTRICAL CHARACTERISTICS**

 ( $V_I=19V, I_O=40mA, 0^\circ C < T_J < 125^\circ C, C_I=0.33\mu F, C_O=0.1\mu f$ , unless otherwise specified)

Parameter	Symbol	Test conditions	SL78L12			UNIT
			MIN	TYP	MAX	
Output voltage	$V_O$	$T_J=25^\circ C$ $V_I=14.5V-27V, I_O=1mA-40mA$ $V_I=19V, I_O=1mA-70mA$	11.5 11.4 11.4	12	12.5 12.6 12.6	V
Load regulation	$Reg_{load}$	$T_J=25^\circ C, I_O=1mA-100mA$ $T_J=25^\circ C, I_O=1mA-40mA$		20 10	100 50	mV
Line regulation	$Reg_{line}$	$14.5V \leq V_I \leq 27V, T_J=25^\circ C$ $16V \leq V_I \leq 27V, T_J=25^\circ C$		120 100	250 200	mV
Input Bias Current	$I_{IB}$	$T_J=25^\circ C$ $T_J=125^\circ C$		4.2	6.5 6.0	mA
Input Bias Current Change	$\Delta I_{IB}$	$16V \leq V_I \leq 27V$ $1mA \leq I_O \leq 40mA$			1.5 0.1	mA
Output Noise Voltage	$V_N$	$10Hz \leq f \leq 100KHz, T_A=25^\circ C$		80		$\mu V$
Ripple rejection	RR	$I_O=40mA, 15V \leq V_I \leq 25V, f=120Hz,$ $T_J=25^\circ C$	37	42		dB
Dropout voltage	$V_I-V_O$	$T_J=25^\circ C$		1.7		V

**ELECTRICAL CHARACTERISTICS**

 ( $V_{IS}=23V, I_O=40mA, 0^\circ C < T_J < 125^\circ C, C_I=0.33\mu F, C_O=0.1\mu f$ , unless otherwise specified)

Parameter	Symbol	Test conditions	SL78L15			UNIT
			MIN	TYP	MAX	
Output voltage	$V_O$	$T_J=25^\circ C$ $V_I=17.5V-30V, I_O=1mA-40mA$ $V_I=23V, I_O=1mA-70mA$	14.4 14.25 14.25	15	15.6 15.75 15.75	V
Load regulation	$\Delta Reg_{load}$	$T_J=25^\circ C, I_O=1mA-100mA$ $T_J=25^\circ C, I_O=1mA-40mA$		25 12	150 75	mV
Line regulation	$\Delta Reg_{line}$	$17.5V \leq V_I \leq 30V, T_J=25^\circ C$ $20V \leq V_I \leq 30V, T_J=25^\circ C$		130 110	300 250	mV
Input Bias Current	$I_{IB}$	$T_J=25^\circ C$ $T_J=125^\circ C$		4.4	6.5 6.0	mA
Input Bias Current Change	$\Delta I_{IB}$	$20V \leq V_I \leq 30V$ $1mA \leq I_O \leq 40mA$			1.5 0.1	mA
Output noise voltage	$V_N$	$10Hz \leq f \leq 100KHz, T_A=25^\circ C$		90		$\mu V$
Ripple rejection	RR	$I_O=40mA, 18.5V \leq V_I \leq 28.5V,$ $f=120Hz, T_J=25^\circ C$	34	39		dB
Dropout voltage	$V_I-V_O$	$T_J=25^\circ C$		1.7		V

**ELECTRICAL CHARACTERISTICS**

 ( $V_i=27V, I_o=40mA, 0^\circ C < T_j < 125^\circ C, C_i=0.33\mu F, C_o=0.1\mu f$ , unless otherwise specified)

Parameter	Symbol	Test conditions	SL78L18			UNIT
			MIN	TYP	MAX	
Output voltage	$V_o$	$T_j=25^\circ C$ $V_i=20.7V-33V, I_o=1mA-40mA$ $V_i=27V, I_o=1mA-70mA$	17.3 17.1 17.1	18	18.7 18.9 18.9	V
Load regulation	$Reg_{load}$	$T_j=25^\circ C, I_o=1mA-100mA$ $T_j=25^\circ C, I_o=1mA-40mA$		30 15	170 85	mV
Line regulation	$Reg_{line}$	$20.7V \leq V_i \leq 33V, T_j=25^\circ C$ $21V \leq V_i \leq 33V, T_j=25^\circ C$		45 35	325 275	mV
Input Bias Current	$I_{IB}$	$T_j=25^\circ C$ $T_j=125^\circ C$		3.1	6.5 6.0	mA
Input Bias Current Change	$\Delta I_{IB}$	$21V \leq V_i \leq 33V$ $1mA \leq I_o \leq 40mA$			1.5 0.1	mA
Output Noise Voltage	$V_N$	$10Hz \leq f \leq 100KHz, T_A=25^\circ C$		150		$\mu V$
Ripple rejection	RR	$I_o=40mA, 23V \leq V_i \leq 33V, f=120Hz,$ $T_j=25^\circ C$	33	48		dB
Dropout voltage	$V_i-V_o$	$T_j=25^\circ C$		1.7		V

**ELECTRICAL CHARACTERISTICS**

 ( $V_{is}=33V, I_o=40mA, 0^\circ C < T_j < 125^\circ C, C_i=0.33\mu F, C_o=0.1\mu f$ , unless otherwise specified)

Parameter	Symbol	Test conditions	SL78L24			UNIT
			MIN	TYP	MAX	
Output voltage	$V_o$	$T_j=25^\circ C$ $V_i=27V-38V, I_o=1mA-40mA$ $V_i=27V-33V, I_o=1mA-70mA$	23 22.8 22.8	24	25 25.2 25.2	V
Load regulation	$\Delta Reg_{load}$	$T_j=25^\circ C, I_o=1mA-100mA$ $T_j=25^\circ C, I_o=1mA-40mA$		40 20	200 100	mV
Line regulation	$\Delta Reg_{line}$	$28V \leq V_i \leq 80V, T_j=25^\circ C$ $27V \leq V_i \leq 38V, T_j=25^\circ C$		50 60	300 350	mV
Input Bias Current	$I_{IB}$	$T_j=25^\circ C$ $T_j=125^\circ C$		3.1	6.5 6.0	mA
Input Bias Current Change	$\Delta I_{IB}$	$28V \leq V_i \leq 38V$ $1mA \leq I_o \leq 40mA$			1.5 0.1	mA
Output noise voltage	$V_N$	$10Hz \leq f \leq 100KHz, T_A=25^\circ C$		200		$\mu V$
Ripple rejection	RR	$I_o=40mA, 29V \leq V_i \leq 35V,$ $f=120Hz, T_j=25^\circ C$	31	45		dB
Dropout voltage	$V_i-V_o$	$T_j=25^\circ C$		1.7		V

## TYPICAL CHARACTERISTICS @ $T_a=25^\circ\text{C}$ unless otherwise specified

**Figure 1. Dropout Characteristics**

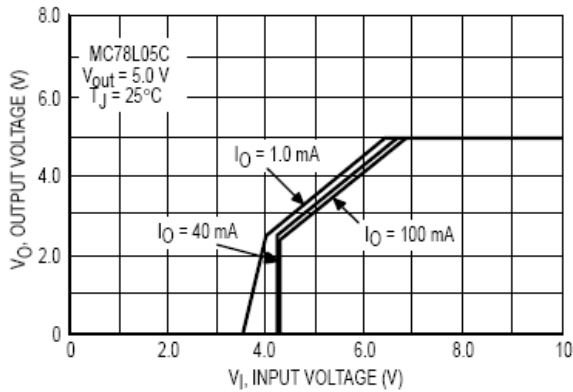

**Figure 2. Dropout Voltage versus Junction Temperature**

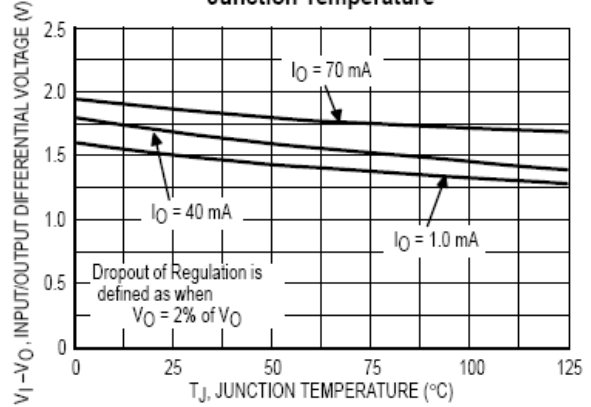

**Figure 3. Input Bias Current versus Ambient Temperature**

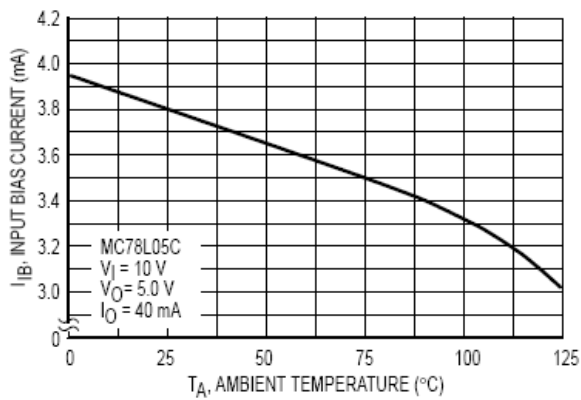

**Figure 4. Input Bias Current versus Input Voltage**

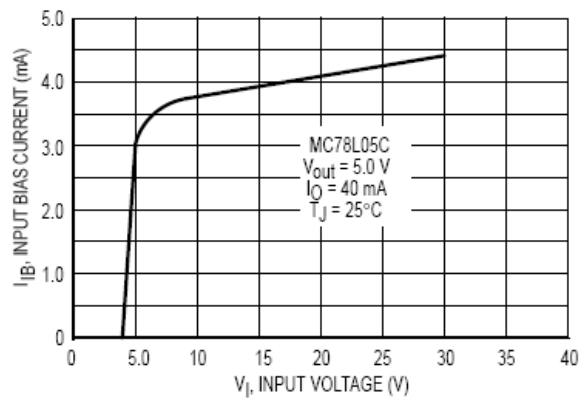

**Figure 5. Maximum Average Power Dissipation versus Ambient Temperature – TO-92 Type Package**

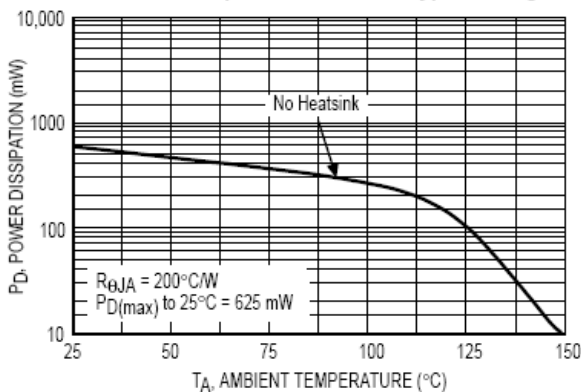

**Figure 6. SOP-8 Thermal Resistance and Maximum Power Dissipation versus P.C.B. Copper Length**

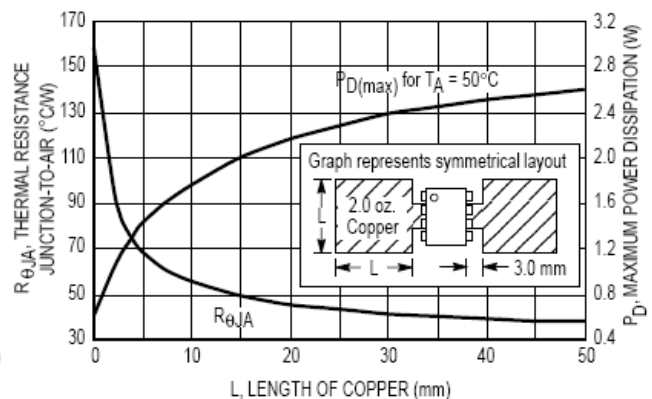



## PACKAGE OUTLINE

Plastic surface mounted package

SOT-89

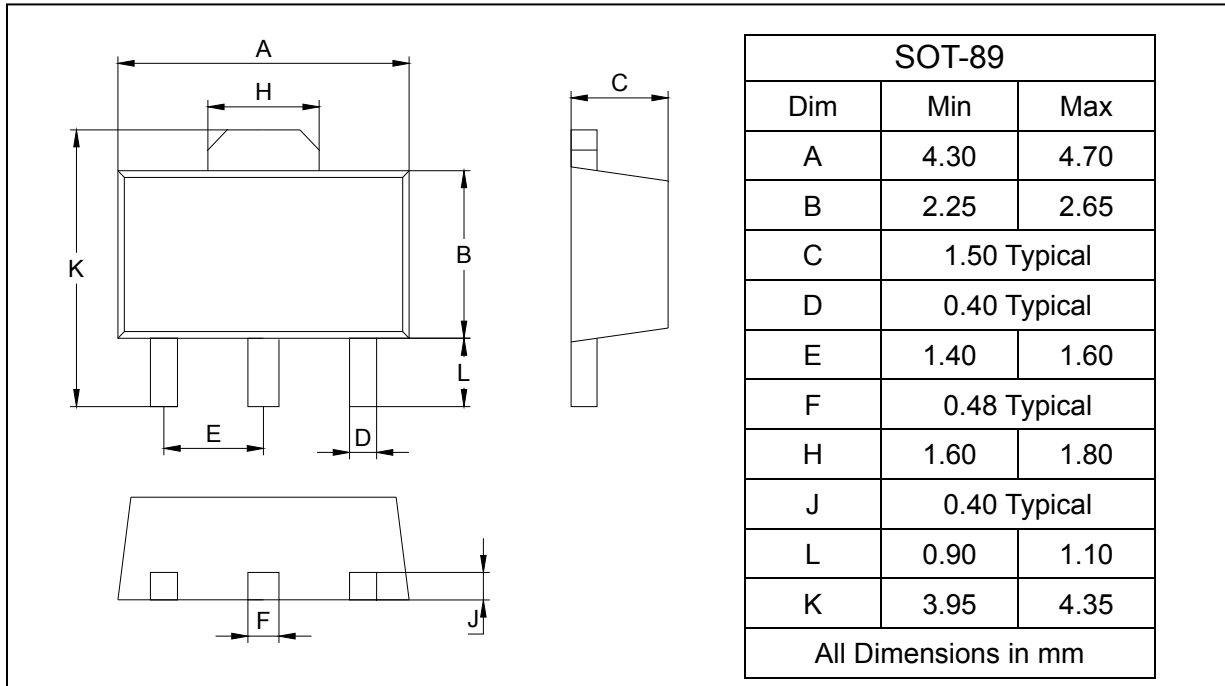

## SOLDERING FOOTPRINT

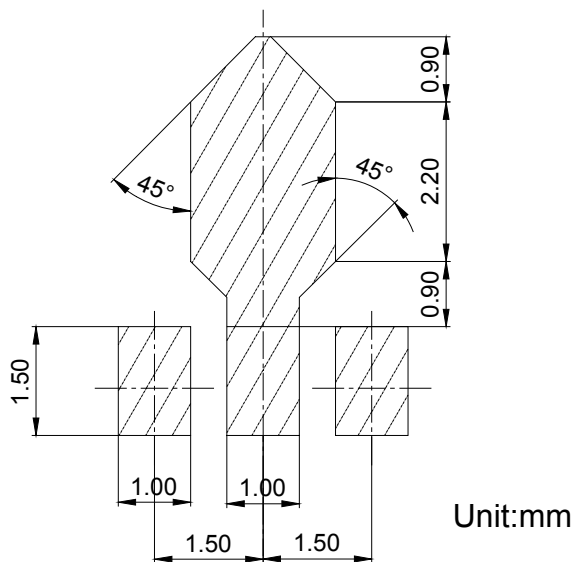

## PACKAGE INFORMATION

Device	Package	Shipping
SL78LXX	SOT-89	1000/Tape&Reel